

Name: ADRIAN  
 Date: 13/10/2019  
 Track: CNETIC

**Track conditions**  
 Size:  Open  Med.  Tight  
 Traction:  High  Med.  Low  
 Surface:  Smooth  Med.  Bumpy

**Result**  
 Race time / Lap: \_\_\_\_\_  
 Best lap (1Lap): \_\_\_\_\_

**Front suspension**

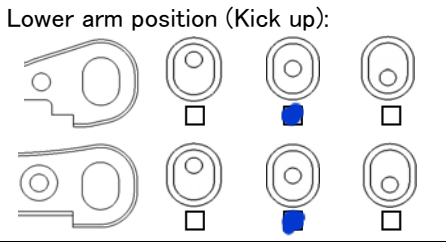
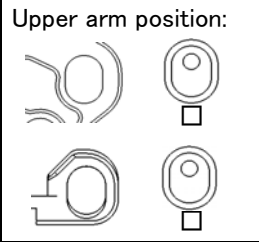
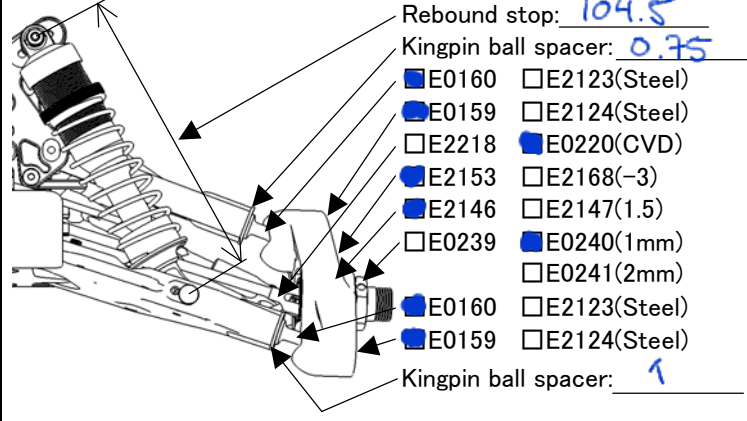

Ride height: 24  
 Toe angle: 25.5  
 Lower arm plate:  E2144A,B  E2154(CFRP 1mm)  E2155(CFRP 1.2mm)  
 Anti roll bar: 2.5  
 Upper arm spacer: 2  
 Lower arm spacer: 0

**Front shocks**

Piston: 1.2x8 Oil: 47.5  
 Spring: 5.0  
 Shock position: CLEAR  
 Pivot ball position:  Front  Rear  
 Damper stay:  E2562(Aluminum)  E2565(CFRP)

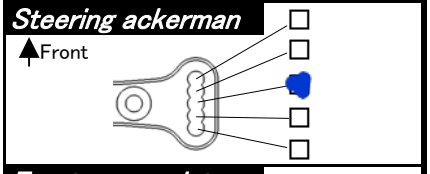

**Front upper plate**

E2148D  E2158(CFRP)  
**Servo saver arm**  
 E2301A  E2310(Aluminum)

**Rear suspension**

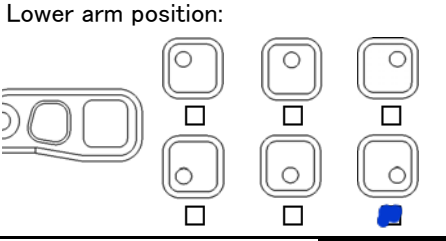
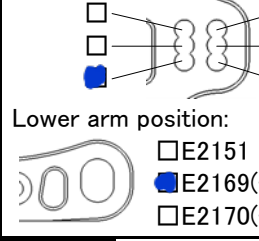
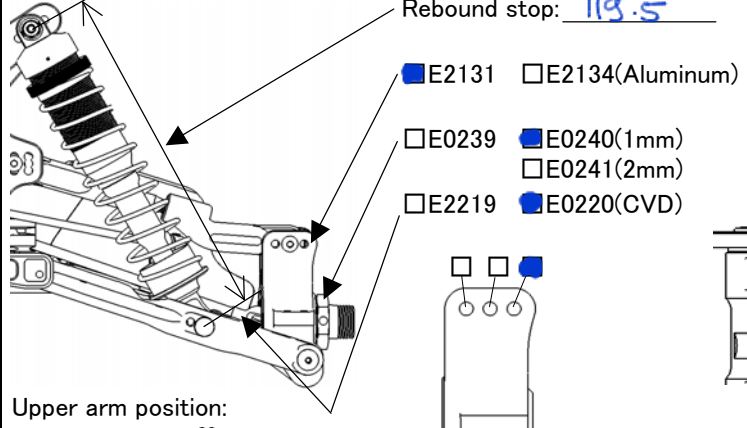

Ride height: 27  
 Camber angle: 19.75  
 Lower arm plate:  E2145A,B  E2156(CFRP 1mm)  E2157(CFRP 1.2mm)  
 Anti roll bar: 2.7  
 Lower arm spacer: 0  
 Upright spacer: 2.5

**Rear shocks**

Piston: 1.3x8 Oil: 49.5  
 Spring: 10.5  
 Shock position: BLUE  
 Pivot ball position:  Front  Rear  
 Damper stay:  E2563(Aluminum)  E2566(CFRP)

**Center shaft**

E2228,E2229  
 E0223,E0259(CVD)  E2261,E2262  
**Tension rod**  
 Front:  E2107A(Long)  E2107B(Short)  
 Rear:  E2148C  E0803(Rubber)

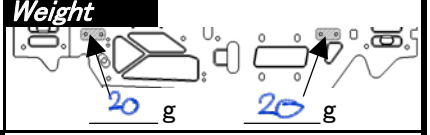

**Engine**  
 Type: NINJA BOS Plug: P3 GOLD Reducer: 6.5  
 Muffler: 2100/90 Fuel: RT 25% Gasket: STD  
 Engine mount:  E0701(Standard)  E2713(One piece)

**Diff. gear**

Front:	<input checked="" type="checkbox"/> 44/13T	<input type="checkbox"/> 42/12T	<u>15,000</u>
Rear:	<input checked="" type="checkbox"/> 44/13T	<input type="checkbox"/> 42/12T	<u>7,000</u>
Center:	<input type="checkbox"/> 44T	<input type="checkbox"/> 45T	<input checked="" type="checkbox"/> 46T
	<input type="checkbox"/> 47T	<input type="checkbox"/> 48T	<u>10,000</u>

**Tires**

Type:	<u>POSITIVE</u>	
Compound:	<u>X2</u>	
Inserts:	<u>PL</u>	
Wheel:	<u>MUGEN</u>	

**Clutch**

Clutch bell:	<input checked="" type="checkbox"/> 13T	<input type="checkbox"/> 14T						
A	<input checked="" type="checkbox"/> C0754	<input type="checkbox"/> E0704	<input type="checkbox"/> E0710	<input type="checkbox"/> φ0.9	<input type="checkbox"/> φ0.95	<input type="checkbox"/> φ1.0	<input type="checkbox"/> φ1.05	<input checked="" type="checkbox"/> φ1.1
B	<input checked="" type="checkbox"/> C0754	<input type="checkbox"/> E0704	<input type="checkbox"/> E0710					<input checked="" type="checkbox"/>
C	<input checked="" type="checkbox"/> C0754	<input type="checkbox"/> E0704	<input type="checkbox"/> E0710			<input checked="" type="checkbox"/>		<input checked="" type="checkbox"/>

**Body/Wing**

Body: MBX 8  
 Wing: HB  
 Wing stay:  E2422A  E2428A(+15)  
 Wing position:  Front

**Comments**

.....  
 .....  
 .....